

PRODUCT SHEET

Description:

Flap Hinge $\varnothing 35 \times 12 \text{ mm}$, Zamak, Black, W/Cover Plates, Detachable From 16mm Panel Thickness, Hidden Screws

Item number:

15.09.051-0

Units	Box	Carton	HS Code	Barcode
Pcs.		250	8302100090	

5704866516938

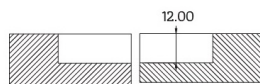
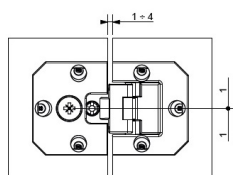
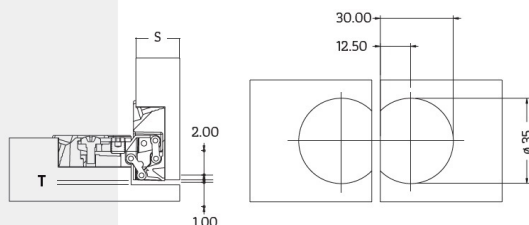
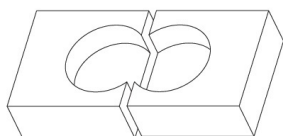
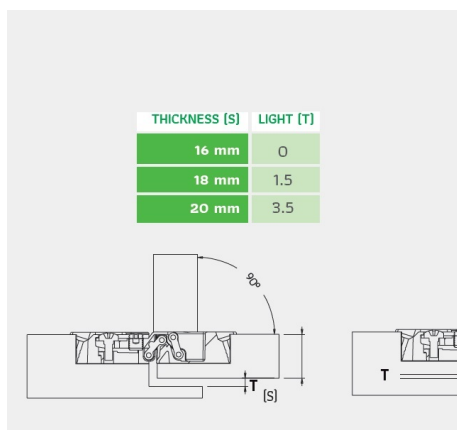
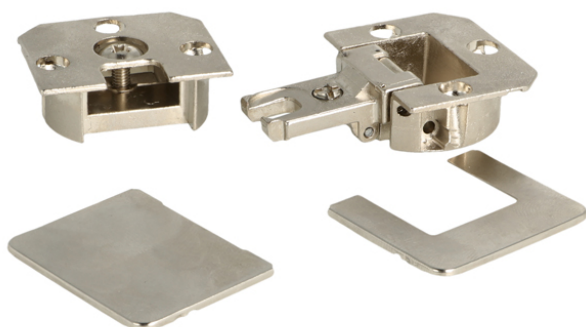

SISO A/S

Mileparken 11
DK-2740 Skovlunde
Denmark
VAT: 24786013

Phone +45 45 830 900

www.siso.dk
siso@siso.dk

Danske Bank
Nytorv Branch
Copenhagen
SWIFT: DABADKKK

Account no.
4180 3112 112936
IBAN Account
DK7230003112112936